

Data Sheet



Article number: 201140025

Description: E+G Indexing plunger
GN 7336.7-53-M12x1,5-6

Measures

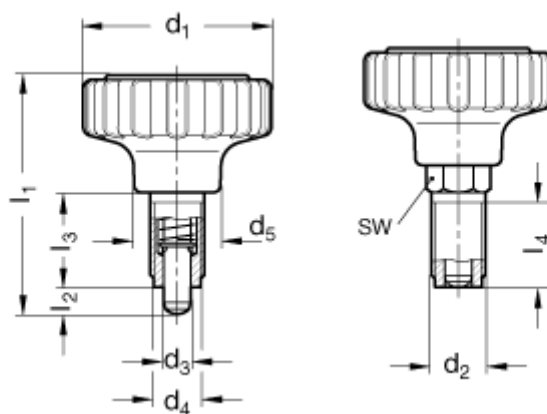

$d_1 = 53$

$d_2 = M 12 \times 1,5$

$d_3 = 6$

$d_4 = 9,9$

$d_5 = 22,5$

$l_1 = 59$

$l_2 = 6$

$l_3 = 21$

$l_4 = 19$

$N = 9$

$sw = 12$